

Linear guide rails

LFS-8-1 LFS-8-2

Figure:
LFS-8-1 with
aluminium slide WS 1/70

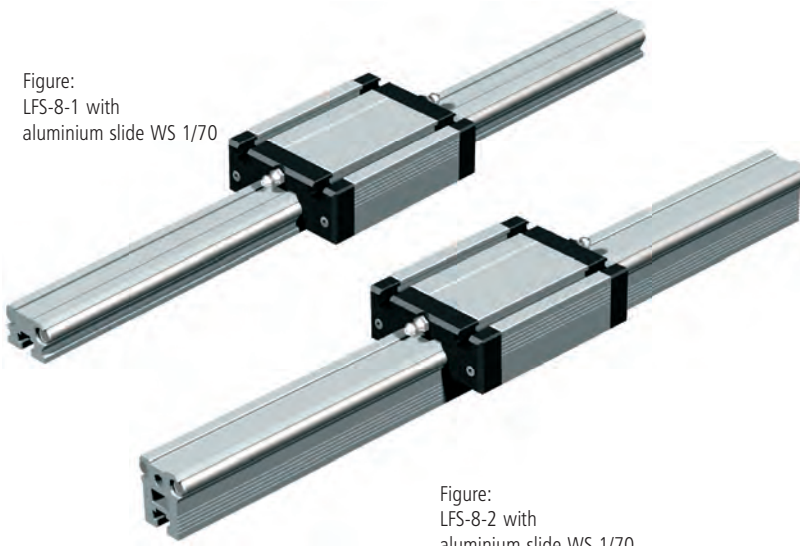

Figure:
LFS-8-2 with
aluminium slide WS 1/70

Features

- W 30 x H 20 mm (LFS-8-1)
W 30 x H 32.5 mm (LFS-8-2)
- 2 precision steel shafts Ø 8
- Anti-twist lock
- Aluminium shaft housing profile, naturally anodised
- Fixing from below with M6 tapped rails in the T-key insert
- Conditionally self-supporting
- Special lengths to order
- Weights: approx. 1.6 kg/m (LFS-8-1)
approx. 2.0 kg/m (LFS-8-2)

Options:

- Stainless steel version
- Drilled for M6 (LFS-8-1 only)

Ordering key

235 00X XXXX

LFS-8-1/standard = 0 Length in mm (in 100 mm raster)
LFS-8-1/stainless = 1 e.g. **0029** = Length 298
LFS-8-2/standard = 2 **0299** = Length 2998
LFS-8-2/stainless = 3 Steel shaft length: total length L - 3 mm

Profile up to 6000 mm available without impact connection, steel shafts divided.

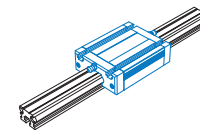

Aluminium slide

- With recirculating ball guide
- Clamping surface plane milled
- M6 T-key inserts
- Central lubrication option
- Adjustable for no play
- Option: stainless steel version

Load data

Shaft slide WS 1/70	
C ₀	3114 N
C	1846 N
F ₁ static	2659 N
F ₁ dynamic	1576 N
F ₂ static	3114 N
F ₂ dynamic	1846 N
M _x static	37.3 Nm
M _y static	100.5 Nm
M _z static	117.6 Nm
M _x dynamic	22.1 Nm
M _y dynamic	59.5 Nm
M _z dynamic	69.7 Nm

Shaft slide WS 1	
C ₀	4590 N
C	2390 N
F ₁ static	3920 N
F ₁ dynamic	2041 N
F ₂ static	4590 N
F ₂ dynamic	2390 N
M _x static	55.0 Nm
M _y static	148.1 Nm
M _z static	173.4 Nm
M _x dynamic	28.6 Nm
M _y dynamic	77.1 Nm
M _z dynamic	90.2 Nm

Trolley LW 6	
C ₀	2160 N
C	4000 N
F ₁ static	4320 N
F ₁ dynamic	3792 N
F ₂ static	2160 N
F ₂ dynamic	4000 N
M _x static	121.1 Nm
M _y static	194.4 Nm
M _z static	97.2 Nm
M _x dynamic	106.3 Nm
M _y dynamic	170.6 Nm
M _z dynamic	180.0 Nm

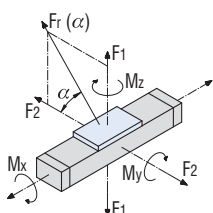

$$Fr(\alpha) = \frac{F_2}{\cos \alpha}$$

$$Fr(\alpha) = \frac{F_1}{\sin \alpha}$$

L 96 × W 72 × H 28.5 mm (WS 1/70)
(weight: approx. 0.4 kg)

Part no.: **223100 0070**
Stainless steel: **223101 0070**

L 126 × W 72 × H 28.5 mm (WS 1)
(weight: approx. 0.5 kg)

Part no.: **223100**
Stainless steel: **223101**

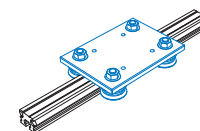

Trolley LW 6

- L 125 x W 90 x H 7.7 mm
- ground steel plate
- 4 rollers Ø 31, sealed for life
- adjustable for no play
- weight: approx. 1 kg

Part no.: **223011**

Linear guide rails

LFS-8-1 LFS-8-2

Bending

■ Load config. 1

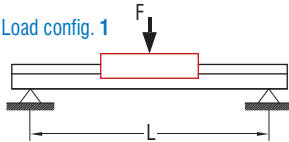

■ Load config. 2

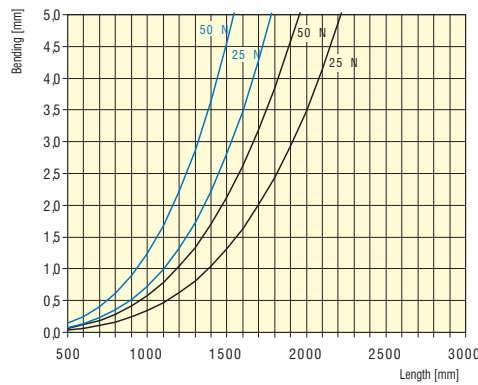
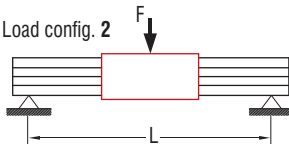

LFS-8-1

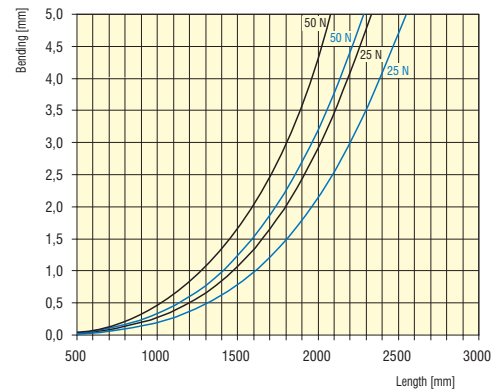

LFS-8-2

Dimensioned drawings

LFS-8-1 or LFS-8-2 with aluminium slide WS 1/70 or WS 1

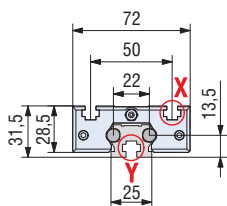

LFS-8-1

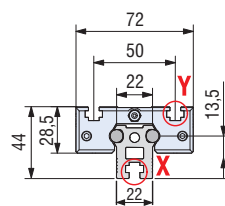

LFS-8-2

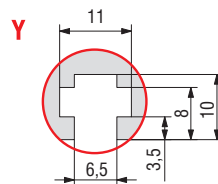
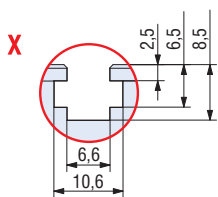
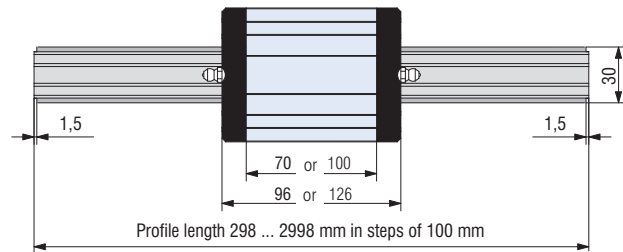

LFS-8-1 or LFS-8-2 with trolley LW6

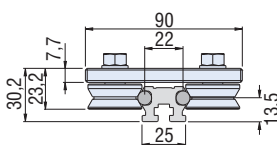

LFS-8-1

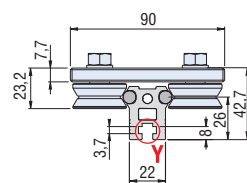

LFS-8-2

